

MKT "McKiernan-Terry" MODELS 9B3, 10B3 & 11B3

MECHANICAL-VALVE DOUBLE ACTING PILE HAMMERS

Models 9B3,
10B3 & 11B3
Mechanical
Valve
Double-Acting
Pile Hammers

PAGE ONE

THE ORIGINAL DOUBLE-ACTING PILE HAMMERS INCREASE PRODUCTIVITY!

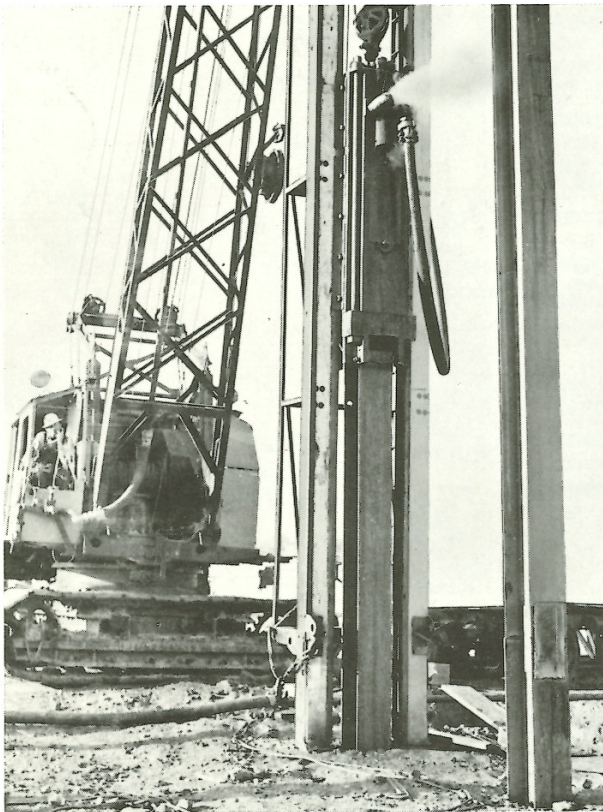

- Overcome skin-friction with high-speed blows.
- Use pile momentum to get fast penetration.
- Protect workers and internal hammer parts by full enclosure.
- Mount quickly in standard leads, pants, skirts, or on a spud.
- Deliver, high-production, encushioned, ram-to-pile blows.
- Increase reliability with alloy-steel, impact parts.
- Simplify maintainability with easy-to-disassemble, self-contained sub assemblies.
- Save pile cut-offs by operation submerged, under water.
- Power with steam or air.

If you install deep, water or sewer line, sheeted trenches, heavy, timber, pipe or H-beam foundations; coffer dams; sheet retaining walls; underwater pier piling; anchor or fender pile, in normal soils such as sand, silt or loam; or, if you break underwater rock, an MKT, Double-Acting, Mechanical Valve Pile Hammer should be in your equipment inventory. For more profitable pile driving, consult your MKT representative about these hammers.



OPERATION AND BASE ATTACHMENTS

The unusual power and the reliability of the Mc-Kiernan-Terry double-acting hammers is primarily due to their trouble-free valve system. In the B3 series, the valve is thrown by a mechanical system with a minimum of moving parts.

The ram carries a rigidly connected cam throw which engages a cam rod suspended in the intermediate head of the hammer. In operation, the motive fluid first enters the inlet port and flows through the lower opening of the valve to the underside of the piston. The top opening of the valve completes a path from the top side of the piston to the exhaust port. As the fluid lifts the piston, thus lifting the ram, the lugs of the cam throw slide past the edges of the cam rod until, at the top of the stroke, they engage a spiral portion of the cam rod, causing it to rotate. The valve connected to the top of the cam rod also rotates, allowing the inlet motive fluid to enter the top of the cylinder, and permitting the exhaust fluid on the underside of the piston to escape through the exhaust port.

The ram then falls, its velocity increased by the fluid pressure on the top of the piston. The cam throw lugs slide down along the cam rod to the bottom of the stroke where another spiral portion of the cam rod is engaged. The cam rod rotates, rotating the valve to the original position, and the motive fluid path reverses.

It can be seen that, in the B3 double-acting hammers, motive fluid is working both on the upstroke and the downstroke. On the downstroke the total velocity of the ram is due to both gravity and to fluid pressure pushing downward on the piston. The mechanical valving system provides a stroke the length of which is set by the effective length of the cam rod. It therefore assures a full stroke of the ram in every stroke made.

ANVILS AND DRIVE CAPS

B3 hammers come equipped with your choice of flat or cup (timber) anvil block. For maximum driving efficiency, lowest pile damage, close-pile-fitting anvils or drive caps are available. Anvils are an integral part of the hammer, transmitting the ram-blow directly to the pile head. Drive Caps are slung under a flat anvil block and serve as an adaption to the pile head. See the MKT Accessories bulletin for details.

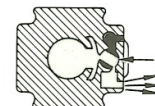
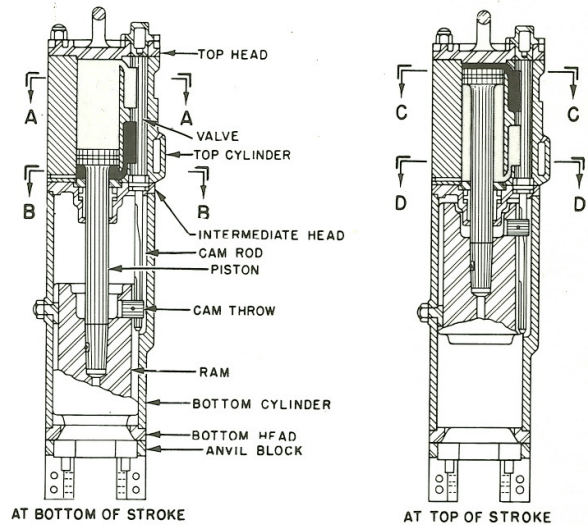

SECTION AA

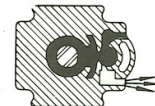

SECTION BB

■ INLET FLUID
□ EXHAUST FLUID



SECTION CC

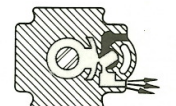

SECTION DD

UNDERWATER DRIVING

The B3 Hammer's versatility permits piling to be driven to cut-off with the hammer submerged as much as 80 feet beneath the surface. By thus eliminating the need for followers, piling can be driven faster, more economically, and with greater positional accuracy.

A hose attachment is required to adapt the 9B3, 10B3, and 11B3 hammers for underwater driving. This attachment, a one-inch air inlet hose connected to the pipe tap in the bottom cylinder, is illustrated at right. At least sixty cubic feet of air per minute must be supplied through this hose to the bottom cylinder during its entire period in the water. One-half pound of pressure is required for every foot of submersion.

The exhaust must be vented (for underwater driving) to the surface through a hose extension. Minimum hose diameters are specified as size of exhaust openings for the individual hammers.

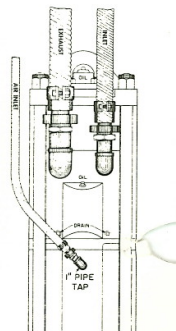

SPECIFICATIONS AND APPLICATIONS

Models 9B3,
10B3 & 11B3
Mechanical
Valve
Double-Acting
Pile Hammers

PAGE THREE

| OPERATING DATA | 9B3 | 10B3 | 11B3 |
|---|------|--------|--------|
| Weight of Ram, pounds | 1600 | 3000 | 5000 |
| Rated Striking Energy, per blow, foot-pounds | 8750 | 13,100 | 19,150 |
| Rated Speed, Blows per minute, Normal | 145 | 105 | 95 |
| Boiler Horsepower required, | 85 | 104 | 126 |
| Compressed Air Required, Actual Cubic Feet in Hammer | 600 | 750 | 900 |
| Steam or Air Pressure required at hammer, | 100 | 100 | 100 |
| Min. Size Hose Openings & Connections from Boiler/Comp. to hammer, inches | 2 | 2½ | 2½ |
| Size of Exhaust Openings in Hammer, inches | 3½ | 4 | 4 |
| Bore, inches | 8½ | 10 | 11 |
| Stroke, inches | 17 | 19 | 19 |
| Net Weight with Flat or Bell (cup) Anvil, Hammer only, pounds | 7000 | 10,850 | 14,000 |
| Shipping Weight Hammer & Fittings, pounds | 7100 | 11,000 | 14,200 |

| DIMENSIONS | 9B3 | 10B3 | 11B3 |
|--|------|------|-------|
| A Overall Length, Top of Bail — to Bottom of Retainer Legs | 99¼" | 110" | |
| A ₁ Top of Sheave to Bottom of Retainer Legs | | | 133½" |
| B Overall Length, Top of Bail — to Bottom of Anvil | 90" | 101" | |
| B ₁ Top of Sheave to Bottom of Anvil | | | 124¾" |
| C Overall Width | 20" | 24" | 26" |
| D Overall Depth | 25" | 27¼" | 29" |
| E Circular Clearance Between Retainer Legs | 15" | 19" | 22" |
| F Center Line of Hammer to Rear of Hammer | 11½" | 12¾" | 13¾" |
| G Center Line of Hammer to Front of Hammer | 13½" | 14½" | 15¼" |
| H Lateral Distance Between Retainer Legs | 9" | 11" | 13½" |
| J Depth of Hammer at Base | 20" | 24" | 26" |
| K Maximum Back to Back Spacing, Angle-Iron Guides | 8½" | 10¼" | 15" |

NOTE:
ON 9B3 P.H. RAM GUIDE NUT IS ON BACK OF HAMMER.

NOTES:

1 Boiler horsepower is given in ASME rating.

2. Since the volume and pressure of compressed air delivered to a hammer will vary with compressor condition, weather, length and condition of the air line, and other varying factors, air consumption is given in this manner. Generally, to assure satisfactory hammer operation, your compressor should be able to deliver 150% of this actual compressed air volume.

3. Steam or air pressure is given at the hammer in pounds per square inch. Pressures required at the boiler or air compressor will vary with weather, installation of the boiler, length and type of steam or air line used. Steam pressure must be regulated at the prime mover to run the hammer to speed.

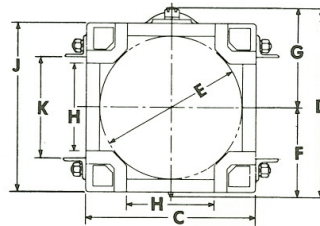
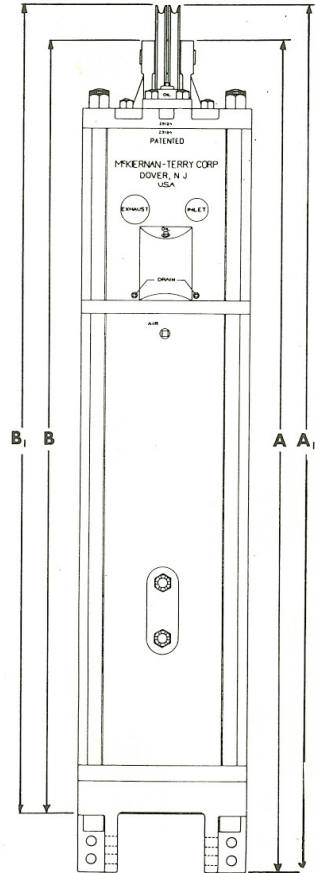

APPLICATION GUIDE FOR DOUBLE-ACTING HAMMERS

| Hammer Model | 9B3 | 10B3 | 11B3 |
|--|--|----------------|----------------|
| Typical Site Conditions | Common soil such as sand, loose gravel, silt & loam and submerged under water. | | |
| Typical max. pile bearing load — tons | 45 | 65 | 95 |
| Timber pile — Normal max. diameter, inches Typical penetration, feet | 14 30-40 | 18 50-70 | 22 60-100 |
| Pipe pile — Normal max. diameter, inches OD Typical penetration, closed-end, feet | 16 30-40 | 18 50-65 | 20 70-95 |
| H-beam — Normal max. size, inches Typical penetration, feet | 12 BP 30-45 | 12 BP 60-80 | 14 BP 65-85 |
| Steel sheet — Normal max. depth, inches Typical penetration, two sheets at a time, feet | 12 20-30 | 12 50-70 | 12 85-110 |



PACO Equipment | USA (WA/CA) - CANADA (Alberta / BC / Saskatchewan)

Corporate Office: 250 S. Webster Street Seattle, WA 98108 | 800.658.6379 | pacoequip.com

BEARING CAPACITY AND ORDERING INSTRUCTIONS

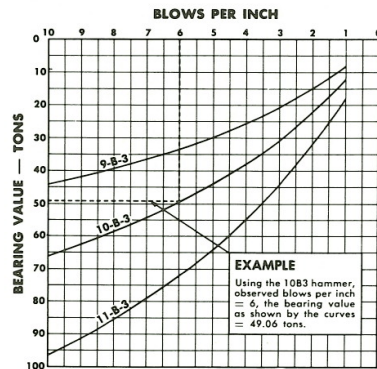

Pile static load bearing curves for McKiernan-Terry 9B3, 10B3 and 11B3 double-acting pile hammers. The curves are derived using the Engineering News Formula:

$$\text{Static load bearing capacity (pounds)} = \frac{2E}{S + 0.1}$$

where E = manufacturer's rating in foot-pounds (9B3 = 8750; 10B3 = 13,100; 11B3 = 19,150), and S is the penetration in inches per blow.

BLOW FREQUENCY AND STRIKING FORCE

The working speed or blow rate of a pile hammer depends on three conditions: the stroke of the ram, the fluid pressure, and the rebound of the ram after striking anvil. Though the fluid pressure and the rebound of the ram will vary according to external control or conditions, the stroke of the ram is fixed by the dimensions of the hammer and the design of the hammer's valve system. Hence, though a short stroke hammer will run at a greater blow frequency than a long stroke hammer, the ram stroke of any McKiernan-Terry hammer cannot usually be changed.

Unlike the stroke of the ram, the two remaining speed factors, the fluid pressure and the ram rebound, are variable. Of these two, only fluid pressure, is controlled by the operator at the throttle. He will thus increase or decrease the force which, in the B3 hammers, both lifts the ram and then assists the force of gravity during the ram's fall. The greater the fluid pressure, the faster the ram will travel.

The remaining variable, the amount of ram rebound, also affects the working speed of the hammer. Rebound cannot be controlled by the hammer operator, but depends upon the resistance offered by the pile. As a consequence, in stiff driving, ram rebound is much greater than during soft driving,

when the ram's energy is fully absorbed. Since the increased rebound of the ram from a stiff, resistant pile aids the lifting force of the motive fluid, it also increases the ram's upward velocity, thus producing a higher blow rate.

ENERGY RATINGS OF B3 HAMMERS

The contribution of the ram rebound to the increased blow rate is taken into account in the calibration of the McKiernan-Terry B3 hammers, and hence does not significantly influence striking energy. Therefore, as blow rate and striking energy vary directly, change of blow rate in itself serves as a measure of the change in striking energy.

Striking energies of the 9B3, 10B3 and 11B3 hammers, as shown in the table, are the actual foot-pound blows at listed speeds, determined by careful calibration of the hammers and by use of precision laboratory equipment and techniques.

B3 HAMMER BLOW RATE AND FT.-LB. BLOW

| HAMMER | Strokes per Minute | Ft.-Lb. Blow |
|--------|--------------------|--------------|
| 9B3 | 145 | 8,750 |
| | 140 | 8,100 |
| | 135 | 7,500 |
| | 130 | 6,800 |
| 10B3 | 105 | 13,100 |
| | 100 | 12,000 |
| | 95 | 10,900 |
| | 90 | 9,550 |
| 11B3 | 95 | 19,150 |
| | 90 | 18,300 |
| | 85 | 17,500 |
| | 80 | 16,700 |

ORDERING INFORMATION

Hammers are furnished with Anvil Block, Lubricator, Angle-Iron Guides attached, basic fittings and special tools.

Anvil Blocks — A Flat or Cup Anvil is furnished within the unit price of the hammer. Specify which is desired. Other Anvils and Drive Caps are available at additional cost.

Lubricator — Either a steam or air line lubricator is furnished within the unit price of the hammer. Specify whether the hammer will be operated with compressed air or steam.

Angle-Iron Guides — Hammers are drilled, tapped and provided with angle-iron guides attached within the unit price. If angle-iron guides are desired, specify the lead rail width for which they are to be attached (see maximum spacing in specifications). Angle-Iron Guides built out to greater than the hammer width are available at additional cost.

WE RESERVE THE RIGHT TO AMEND THESE SPECIFICATIONS AT ANY TIME WITHOUT NOTICE. THE ONLY WARRANTY APPLICABLE IS OUR STANDARD WRITTEN WARRANTY. WE MAKE NO OTHER WARRANTY, EXPRESSED OR IMPLIED.

